



Event Video Player

EVP380



Show control player
Audio - Video 4K - DMX/Art-Net

USER MANUAL

SUMMARY

A - Safety instructions.....	P1
B - Product information.....	P3
1 - Product presentation	P4
2 - Main fonctionnalités.....	P4
3 - Installation	P5
4 - Operating mode.....	P10
5 - DMX and show control	P21
6 - Timestamped Programming control (Scheduler).....	P29
7 - RS232 serial link protocol.....	P32
9 - Ethernet.....	P36
9 - Menu	P37
Appendix A : Characteristics.....	P41
Appendix B : Infrared remote control.....	P44
Appendix C : Mapping input / folder	P45
Appendix D : Accessories.....	P46
Appendix E : Frequently questions.....	P47

ID-AL products are exclusively manufactured by Waves System

LA VILLE EN BOIS - 44830 BOUAYE - FRANCE

Sales and informations: +33 2 40 78 22 44

E-mail : info@id-al.com - Web site: <http://www.id-al.com>

Technical department : support@wssystem.com

Technical support :

For a detailed list of the technical support options, we suggest you to visit our site www.id-al.com.

Information in this manual is subject to change without notice and do not represent any commitment from Waves System. The equipment described in this manual is supplied under condition of the terms of license specifying the legal use conditions. This manual can't be reproduced or used, in whole or in part, in any form and by any mean, for other use than private, without the written permission from Waves System.

ID-AL is a trademarks of Waves System.

CAUTION! DO NOT EXPOSE TO HUMIDITY & DUST!

Unplug the power supply cable before any servicing

FOR YOUR SAFETY, PLEASE READ THE USER'S GUIDE CAREFULLY BEFORE OPERATING YOUR PLAYER.

A. SAFETY INSTRUCTIONS

A.1 CE marking

The CE marking is found on the nameplate, at the rear side of the device. It certifies the conformance of the device with the low voltage CE Directive, according to the EN 55022 standard, and the Electromagnetic Compatibility Directive 61000-4-x.

A.2 Directives

- The requirements related to the electromagnetic compatibility and low voltages directive are met.

This device is granted a certification of conformity assessment only under the condition that this is used for industrial environment. We advise that if installed for usage in home environment, the electronic interference might take place.

A.3 Overview

- The user manual is an integral part of the product. It must always be kept handy & close by. Proper usage conforming to the product intended purpose involves strict compliance with the instructions given in this manual.

In the event of return of the equipment, the user manual should be handed over to the new purchaser. The staff should receive instructions concerning the proper usage of the device.

- Only usage of genuine parts ensures perfect safety for the user and correct operation of the device. Moreover, only accessories mentioned in the technical documentation or explicitly approved by the manufacturer must be used. In the event of usage of accessories or consumable products from other brands, the manufacturer cannot stand guarantee for the correct and safe operation of the device.

- Damages caused through usage of accessories or consumable products from other brands will not entail right to any benefit under the terms of warranty.

- The manufacturer will be liable for the safety, reliability and functioning of the product as long as the assembly, settings, modifications, extensions and repairs have been carried out by the manufacturer or a company approved by the manufacturer and if the device is used in accordance with the instructions mentioned in this manual.

- The player complies with the technical safety standards in force at the date of print of this manual. All rights reserved for the electrical diagrams, procedures, names and devices mentioned herein.

- Any reproduction of the technical documentation, even partially, without the written authorization from Waves System is prohibited.

A.4 General Safety instructions

This device has been shipped out from our facilities in perfect working condition. In order to preserve these conditions, for safety and to avoid any risk of accidental bodily injury, the user must imperatively follow the safety instructions and read the 'Caution!' messages included in this manual.

This device, made by Waves System, has been designed in a way that practically eliminates any risk if it is used in accordance to its intended purpose. Nevertheless, with a concern for safety, we would like to draw your attention to the following instructions:

- When using the device, comply with all local rules and regulations in force. Any modification or conversion of the device automatically entails loss of the homologation. The operation of a modified device is liable to a penalty. In the interest of occupational safety, the operator and the user are held responsible for complying with the regulations.

- Keep the original packing for a possible product re-shipment. Also ensure to keep the packing material out of children's reach. Only this original packing ensures optimal protection for the product during transportation. If a product reshipment appears to be necessary during the guarantee period, Waves System is not liable for any ensuing damages arising during the transportation and attributable to a defective packing.

- This device is used to broadcast video and audio files. It should be used only by persons whose training or knowledge ensures proper handling.

- Before every use, the operator must check that the device is in perfect working condition.

- This product must not be used in places where there is a potential explosion risk. Besides, it must neither be used in an environment favouring combustion nor in a humid or excessively hot or cold location.

A.5 Safety instructions against risks due to electric currents

- The device must be connected to a grounded AC power outlet or a European standard outlet installed as per good professional practices.

- Before connecting the device, check that the power supply voltage and frequency match the specifications indicated on the device.

- Before powering, check that the device and cables are not damaged. Damaged cables and connections must immediately be replaced.

- Never allow the power cords to come in contact with other cables. Handle the power supply cable as well as all other cables connected to the mains with extreme care.

- Always connect the plug-in connector in the end. Ensure that the On/Off switch is in 'Off' position before connecting the device to the mains. The mains outlet must remain accessible after the installation.

- Check the device and its power supply cable from time to time. Disconnect the device from the mains when it is no longer used or for the purpose of maintenance.

- Handle the power cord by using the plug-in connector only. Never remove the plug-in connector by pulling the power cord.

- Electrical connection, repairs and maintenance must be carried out by qualified personnel.

- Do not switch on or switch off the device within a short span of time as this will reduce equipment life.

A.6 - Terms of use:

- This product has been designed for indoors use only.
- If this device has been exposed to very high temperature fluctuations (e.g.: after transportation), do not connect it immediately. The condensation formed inside the device could damage it. Allow the device to attain ambient temperature before connecting it.
- Do not shake the device, avoid sudden movements during its installation or handling.
- When selecting the spot for installation of the player, ensure that it is not exposed to a high source of heat, humidity or dust. There should not be any cables lying around as they might jeopardise your & others safety.

B. PRODUCT INFORMATION

B.1 Correct usage

The player is used to broadcast audio/video files automatically.

Correct usage involves compliance with the instructions given in this manual as well as with the requirements concerning installation.

B.2 Incorrect usage

Any other usage or usage beyond the scope of this application is considered as incorrect usage. The manufacturer shall not be liable for the damages ensuing from it. The user shall bear full responsibility for the risks incurred.

B.3 Delivery details

Event VideoPlayer EVP380

External power supply and its power supply cable

Remote control

User's manual

B.4 Specifications

Audio/video/DMX Player model : EVP380

Nominal electrical values of the power supply connection

Voltage (V) 100 to 240

Frequency (Hz) 50-60

For details see Annexe B

B.5 Installation

The device must be installed in a dust free area.

Do not install the device directly against a wall. To avoid overheating, the ventilation openings must not be blocked. Take care to leave an empty space above the ventilation slits.

B.6 Electrical connection

Before activation, check whether the mains voltage matches with the voltage indicated on the rating plate.

1 - Product presentation

The Event VideoPlayer is a show controller player to broadcast audio, 4K video, DMX / Art-Net event and managing output contacts. It has been designed to meet the current needs of multisensory management combining image, sound, light and movement.

The Show Control Editor ID-AL software allows you to create and view DMX events on a PC screen in sync with sound and video. A light mixing table or a computer with light software can be connected to the DMX input of the player or the Art-Net network so that the Event VideoPlayer records the shows and then play them.

Interactive, this player responds to commands on its input contacts, through its scheduling function or command by RS-232.

With its built-in 4GB memory and audio amplifier, its implementation will be fast with little additional hardware.

2 - Main functionalities

- **Show control player - Audio + video 4K + DMX/Art-Net + trigger output contacts**
- **DMX/Art-Net recorder**
- **Interactivity:** Event VideoPlayer are interactive player that reacts according to events.
 - Playback pattern is defined by the name of the files or the folders
 - Electrical contacts: 8+1 input to trigger files through sensors, push-buttons, relays ...
 - Infrared sensor allows the use of a remote control.
 - Commands through the RS-232 serial link.
 - Commands and update the files on the medias from your Ethernet network.
 - Scheduling function
 - Synchronization between players
- **Line level audio output and amplified audio output**
- **Built-in 4GB memory**
- **Read files from USB flash memory and Micro SD**
- **Autoplay:** EVP380 starts automatically on powering on. This function is configurable and can be disabled.
- **Playback:** The audio files stored on the media can be organized in a particular way to define playback pattern. The playback pattern is defined by the names of the files and the folders, allowing a wide flexibility of use.

3 - Installation



- 1 - DMX input
- 2 - Infrared sensor
- 3 - DMX output
- 4 - LCD display
- 5 - Volume
- 6 - Activity LED

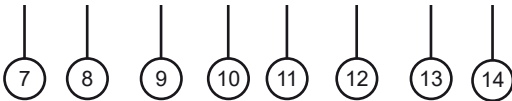
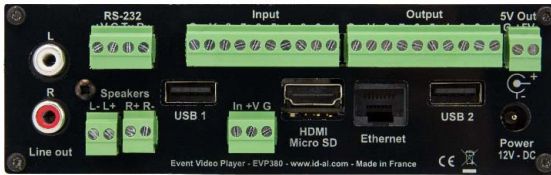

- 7 - Analog audio output
- 8 - Amplified speaker output
- 9 - USB 1
- 10 - Input contact
- 11 - Video/audio HDMI output / Micro SD
- 12 - Ethernet connector
- 13 - USB 2
- 14 - Power supply input
- 15 - RS232 link
- 16 - 8 input contacts
- 17 - 8 output contacts
- 18 - 5V power supply output

First use: EVP380 are factory setting configured with parameters by default and the player must operate on inserting a prepared media dedicated to (chapter 4).

1 - Insert a prepared USB flash memory.



USB flash memory

2 - Connect a display, speakers or a sound system to the audio output and switch on the player thanks to the PSU

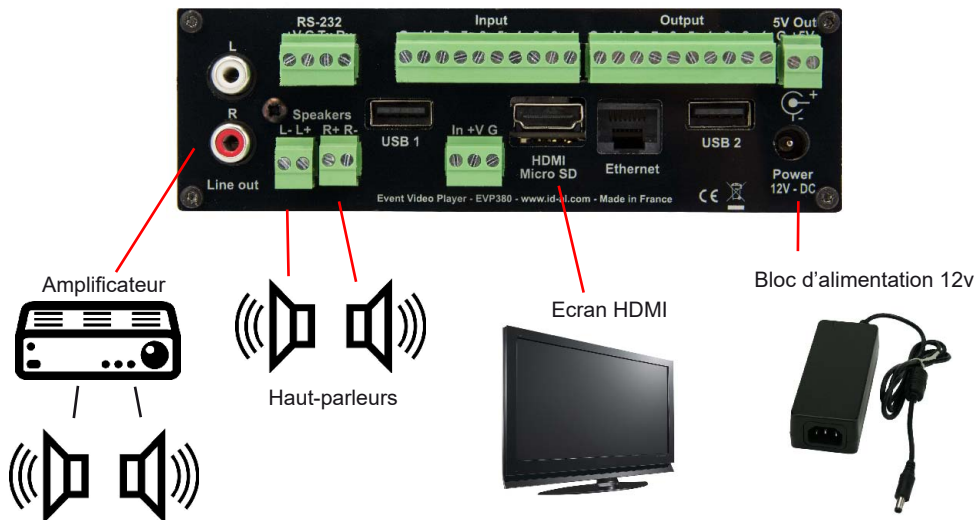

Power Supply Unit: We recommend you to use the PSU provided with the player. If you use another PSU, you have to respect the 12V specified voltage although the player can be power supplied between 10V and 15V. The power consumed depends on the power level of the amplifier.

Preparation of the medias:

Brand new USB flash drive are usually «FAT32» formatted.

If you must format a stick, select the FAT32 format according to the memory size. If the size of the files are over 4GB, select NTFS format. Other types of formatting do not work.

If you use Windows PC computer, latest versions do not allow to format high capacity medias(>32Go) system FAT32. In this case you must obtain a formatting software. Many softwares are available, some free, others payable that you will easily find on internet.

3.1 - Connections

Connection is direct from the sensor/push button to the player trigger input.

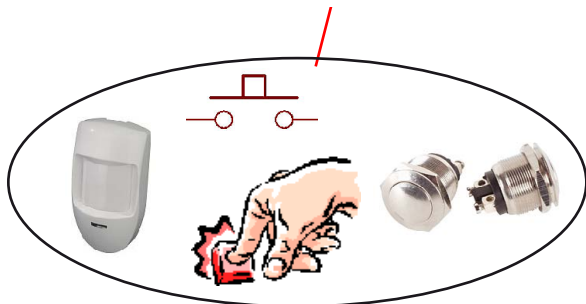
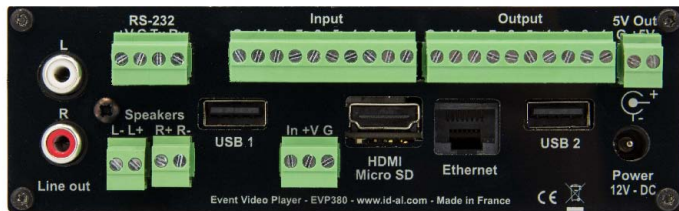

Internal input schematic

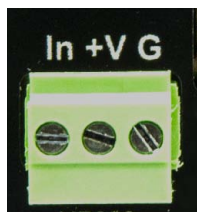
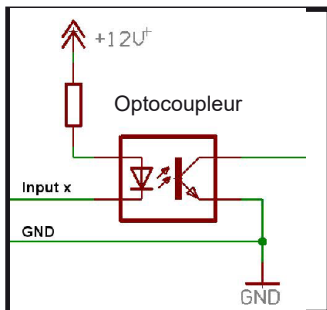

- In - Trigger input
- +V - power supply output for an external peripheral device
- G - Ground

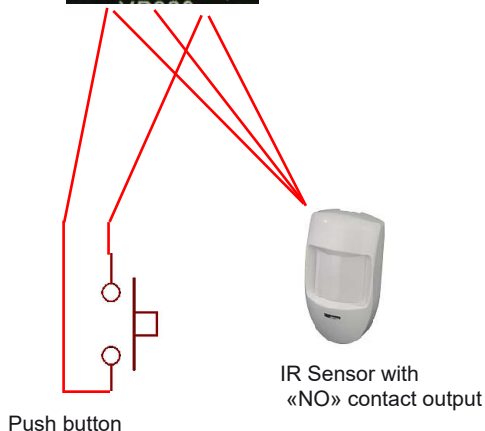

Note: +12v is a transfer of the main external PSU. The provided power will not exceed 500mA.

3.2 - Connections - 8 inputs

Up to 8 inputs, the connections are direct. Over 8 inputs, you need to make a combination using diodes or other electronic system according to binary combination.

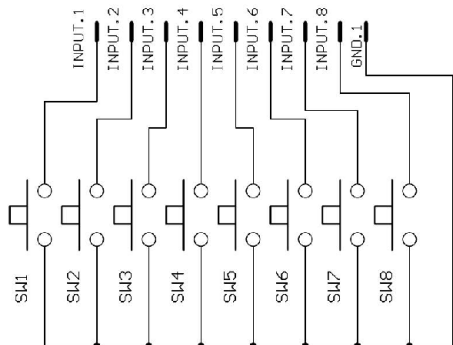

Relation from 8 input to folders name:

- | | |
|------------------|------------------|
| SW1 = Folder 001 | SW5 = Folder 016 |
| SW2 = Folder 002 | SW6 = Folder 032 |
| SW3 = Folder 004 | SW7 = Folder 064 |
| SW4 = Folder 008 | SW8 = Folder 128 |

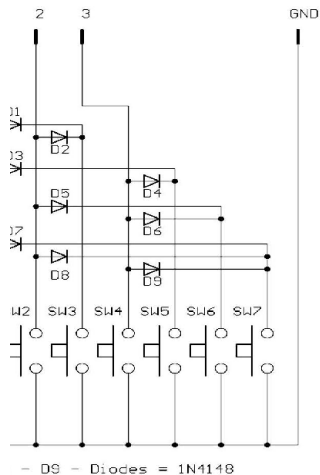

Relation of 3 inputs combination and folder name:

- | | |
|------------------|------------------|
| SW1 = Folder 001 | SW5 = Folder 005 |
| SW2 = Folder 002 | SW6 = Folder 006 |
| SW3 = Folder 003 | SW7 = Folder 007 |
| SW4 = Folder 004 | |

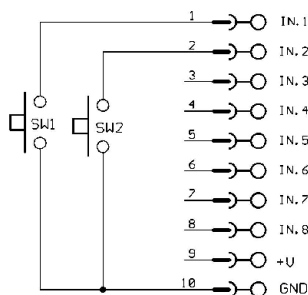

Example to play folder 001 or 002

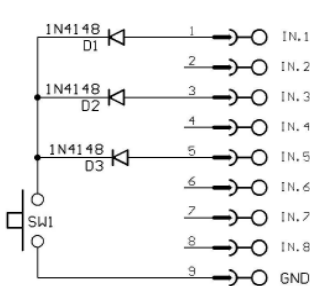

Example of combination to play folder 021

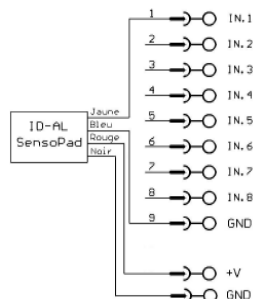

Example for use SensoPad powered by the player to play folder 001

3.3 - Contact output

The Event VideoPlayer can control an output contact to switch on/off some peripherals like LEDs, small motors, relays... The output is setup (on/off) by the name of the folder.

The contact output is an electronic switch named «MOSFET». (see schematic). You can control up to 20V / 500mA max device. You can't control device with high power. In this case, you need to use a relay.

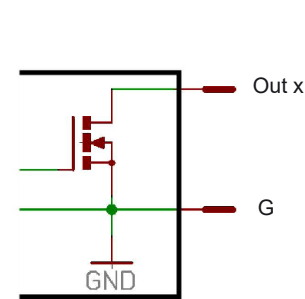

Output schematic

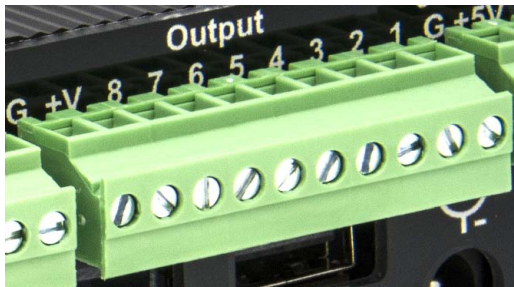
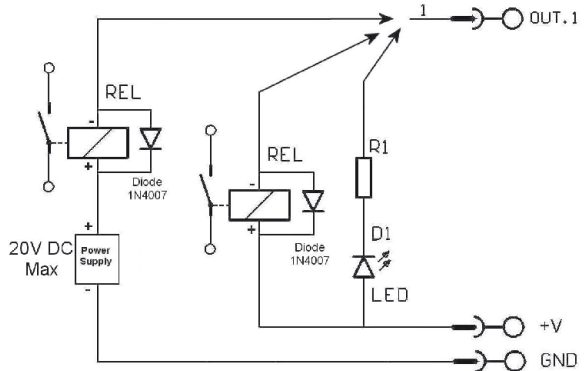

Example of a connection to control a LED in direct or a relay with an external power supply.

Note: +V is a transfer of the main external PSU. The provided power will not exceed 500mA.

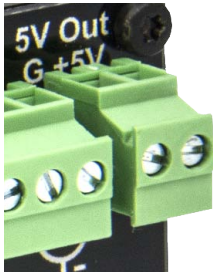

You can use the 5V output to power an external peripheral. Max 1A.

3.3 - DMX / Art-Net connections

DMX is a protocol used in light market to control projector and many peripherals (smoke/fog machine...) and converter (DMX->Relay, DMX->0-10V, DMX->servomotor...)

The Event VideoPlayer offers 3 modes of DMX / Art-Net uses:

- Playback mode: The player play audio/video file at the same time of events files to send commands to the DMX output
- Remote control mode: The player waits the command from DMX or Art-Net input to play audio/video files
- Record mode: The player records data from DMX / Art-Net on its media and then plays the show.

See Show Control chapter for all details.

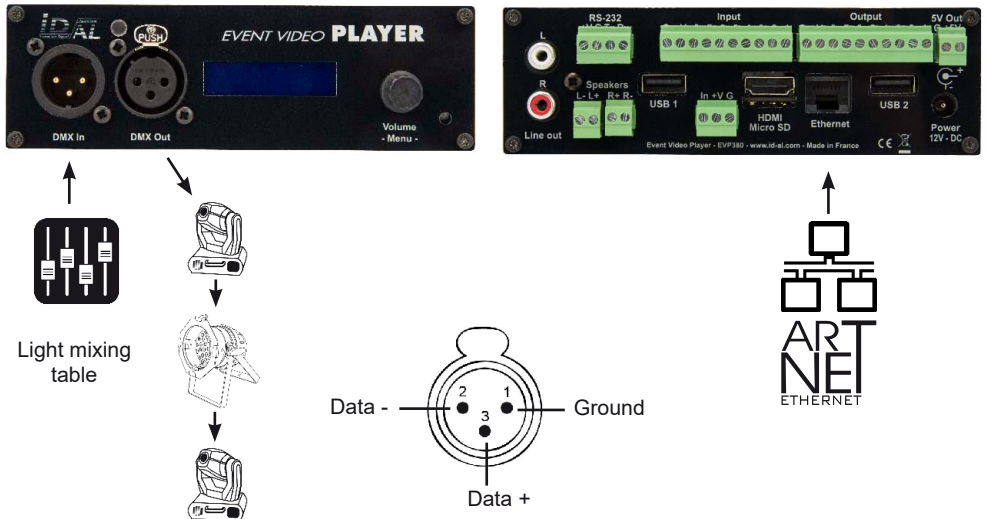

4 - Operating mode

Please, refer to the appendix at the end of this manual for the compatible files.

The name of the files and folders defines the playback mode. The files and folders must be stored and copied according to a specific organisation described below.

4.1 Organisation of folders:

Only ONE folder level is allowed at the root. The folder naming is composed of 3 digits (000 to 999) followed by optional parameters and the name of your choice.

You should not use special or accentuated characters.

Example :

001

003 [J002]

034 folder name

127 [SEQ][J001] my folder

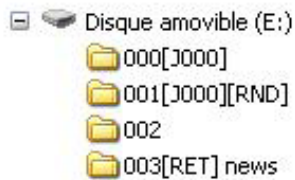

Configuration folder: SYSTEM

SYSTEM folder is used for optional configuration files. See next chapter.

● The first three digits represent the folder number and therefore its main name

Folders are numbered from 000 to 999.

Example :

000 : Folder N°000 - «Autoplay» folder which is automatically played when the device is powered on.

001 : Folder N° 1 - Triggerable by the contact input 1

034 : Folder N° 34

The folder number is used identifies the folder to use during a jump or an input triggering. You can use any number between 000 & 999.

IMPORTANT : The trigger contact input select folder to be played

Please refer to the end of chapter 4 for further informations of use.

Special case: Folder 000 is the folder that will be played by default on powering on. On powering on the presence of this folder is checked ; if present, the player plays the files of this folder.

If the folder is missing, the player is in stop mode.

Additional parameters - Optional Tags:

To modify the conduct of the player, you can add optional parameters within the folder name. These parameters are boxed with the symbols «[« »]». You can add several parameters within the folder name.

[Jxxx]	Jumps to another folder after reading the current folder.
[RET]	Returns to the previous folder after reading the current folder.
[RND] or [SEQ]	Specifies random or sequential playback mode for the current folder.
[V+xx] or [V-xx]	Modifies the volume of the player during the playback of the selected folder
[NT]	Define interruption modes.
[WHL]	Plays the folder while the assigned input combination remains activated.
[NXTxxx]	Plays a specific number of audio files from the folder.
[RESxxxxxxxx] [REExxxxxxxxx]	Actives or deactivates the output contacts when the folder is played or at the end of the folder

Note: If no optional parameter has been indicated, the player reads in sequential the folder in full and then stops. The folder can be interrupted

● **[JXXX] - Jump to the Folder xxx at the End of the Playback of the Folder**

This tag defines the behavior at the end of the playback of the folder. It indicates the 3-digit number (xxx from 000 to 999) of the next folder to play, which can also be the number of the folder itself in order to play it in a loop. By default, if this tag is missing, the playback stops at the end of the folder.

Example :

- 001 [J002] Jump to folder 002 after playing folder 001.
- 003 [J003] Jump to folder 003 after playing folder 003 -> create a loop of the 003 folder.
- 008 [J023] Jump to folder 023 after playing folder 008.
- 458 [J999] Jump to folder 999 after playing folder 458.

To play in a loop some audio files on startup, the folder 000 must be used and tagged with [J000]

● **[LOOP] - Play the folder in loop without the options at each loop.**

With the [Jxxx] option, the other options in the name of the folder are executed at each loop. With the [LOOP] option, the other options are not executed. You can use this function to send RS-232 commands or switch on/off a light when the folder is played or when jump ti other folder and not at each loop.

Example : 001[LOOP]

● **[RESUME] - Save the reading position of the files when returning to the folder.**

When you jump into a folder, the playlist is reset. If you want to return at the previous position with no reset, place [RESUME] in the name of the folder to save the information.

Example : 001[RESUME]

● [RET] - Return to the Previous Folder at the End of the Playback of the Folder

During the playback of a folder, if an event or a tag instructs to play another folder tagged with [RET], then the player jumps to the new folder. At the end of the playback of this new folder, the player jumps back to the initial folder.

This function can be used to resume the playback of a folder interrupted by the playback of a message triggered by an event.

Example:

001 [J100]	After the folder 001 playback, jump to the folder 100.
002 [J100]	After the folder 002 playback, jump to the folder 100.
100 [RET]	After the folder 100 playback, return to the previous folder (001 or 002).

In the above example, after the playback of the folder 001 or 002, the folder 100 is played, then the player jumps back to the initial folder (001 or 002).

Note: The [RET] tag has only one level of return, i.e. the target folder is always the previously played folder, whatever the number of folders tagged with [RET] played in a row.

● [SEQ] or [RND] - Sequential or Random Playback Mode

By default, without this parameter, the folder is played in random mode.

[SEQ]: playback the files of the folder, in alphanumerical ascending order (see the chapter Organization of the Files inside the Folders).

[RND]: playback in a random order.

Example:

001[SEQ]	Play the folder 001 in sequential mode, then stop.
002[RND][J002]	Play the folder 002 in random mode and in a loop.
003[J001]	Play the folder 003 in random mode, then jump to the folder 001.

● [Vxxx] - Volume setting

The name of the folder have an effect on the output volume. This function is used to broadcast messages loud more or less than others files.

Exemple :

001 [V5]	: Volume is set at 5 from 100 steps (00 to 100)
001 [V100]	: Volume is set at 100, maximum value
001 [V00]	: Volume is set at 00, minimum value (Mute)

- If the variation of values exceeds the minimum or maximum values of the player, the levels are settled to their maximum or minimum.

● [V+xx] [V-xx] - Relative Volume of the Folder

This function can be used to play folders (e.g. containing messages) more or less loud than the other folders.

The xx parameter of the tag is the volume of the folder relatively to the main volume against the selected setting value. It is expressed in volume steps.

Example

001 [V+05] Increase the volume level by 5 steps during the folder playback.
001 [V-03] Decrease the volume level by 3 steps during the folder playback.

At the end of the playback of the folder, the volume level goes back to its previous level.

Note: If the resulting volume is out of the allowed volume range of the player, then it is limited to the minimum or maximum value.

● [NT] - Disable the Command Events during the Playback of the Folder

The playback of the folders with this tag cannot be interrupted, and it ignores the instructions received from Input contact, RS-232, TCP/IP, Scheduler...

Example:

001[NT] : The instructions received are ignored during the playback of the folder 001.

However, you can activate some external command manually in the menu if necessary.

● [WHL] - Play the Folder while the Assigned Input Combination Remains Activated

This tag allows to play the contents of a folder as long as the corresponding input combination is activated. When the input combination associated with the folder is deactivated, the player applies the folder exit tags. As long as the corresponding input combination is activated, the folder is played in a loop.

001[WHL] The folder 001 is played in a loop while the input combination 1 is activated. When the input combination 1 is deactivated, the player stops.
002[WHL][J045] The folder 002 is played in a loop while the input combination 2 is activated. When the input combination 2 is deactivated, the player plays the folder 045.
003[WHL][J999] The folder 003 is played in a loop while the input combination 3 is activated (inputs 1 and 2 activated). When the input combination 3 is deactivated (inputs 1 and 2 deactivated), the player plays the folder 999.

The dry contact inputs of the player are combinatorial. Therefore, any changes of the input combination are taken into account at any time by the player.

000[J000] The folder 000 is played in a loop on startup.
001[WHL][J000] The folder 001 is played in a loop while the input combination 1 is activated.
002[WHL][J000] The folder 002 is played in a loop while the input combination 2 is activated
003[WHL][J000] The folder 003 is played in a loop while the input combination 3 is activated (inputs 1 and 2 activated). If the input 1 is released, the player plays the folder 002. But, if the input 2 is released, the player plays the folder 001.

● **[NXTxxx]** - Play the Next xxx Audio Files each Time the Folder is Played

This setting allows to play xxx audio files contained in the folder. Once xxx files have been played, the player applies the folder exit tags. If the number of files requested by this tag is greater than the number of audio files contained in the folder, the player loops in the folder as long as needed in order to play the exact number of audio files requested.

With this tag, the player memorizes the played audio files, meaning that the audio files already played during a previous passing in the folder are not replayed while not all the audio files of the folder have been played.

The xxx parameter of the tag [NXTxxx] is the number of audio files to play in the folder. It is always written with 3 digits (e.g.: 001, 045, 999). It is between 001 and 999.

Example:

001[NXT003]	3 audio files are played in the folder 001, then the player stops.
002[NXT001][J000]	1 audio file is played in the folder 002, then the player plays the folder 000.
004[NXT002][SEQ][J000]	The next 2 files according to the file numbering are played in the folder 004 then the player plays the folder 000.

● **[RESxxxxxxxx]** and **[REExxxxxxxxx]** - Active or deactivate the output contacts

The output contact is switched on/off by the name of the folder when player start to play the folder [RESxxxxxxxx] or at the end of the folder [REExxxxxxxxx].

[RESxxxxxxxx] : x is the state of the output when start to play the folder. 0 = off / 1 = on

[REExxxxxxxxx] : x is the state of the output at the end of the folder. 0 = off / 1 = on

With those 2 options, you can swith on a lamp during the audio file and swith off at the end.

x is the state of the output :

If x = 0, the output is switched off, no contact.

If x = 1, the output is switched on, a contact is made from output to the ground (GND)

Example :

001[RES001111]	4 outputs are switched on when folder 001 starts to be played
002[REE00110001]	3 outputs are switched on at the end of the folder 002
003[REE00000001][REE00000000]	1 output is switched on when start to play the folder 003 and it's switched off at the end of the folder

● [RSSxxx] or [RSExxx] - Send Bytes onto the RS-232 Output

When the folder is called, a list of bytes is transferred by the serial link in order to control other devices (another player, switching grid, projector, ..) The bytes to send are included in a text file that will be especially created for.

Value by default : 19200 Bauds - 8 bits – no parity – 1 bit start – 1 bit stop

You can modify the baudrate manually in the menu.

The file definition of the bytes to send must be named : **serial.txt**

This file will be **copied in the SYSTEM folder** of the media (memory card/flash drive)

[RSSxxx]: xxx appoint the number of the line of the file serial.txt that must be sent (value from 001 up to 999) when player starts to play the folder

[RSExxx] : xxx appoint the number of the line of the file serial.txt that must be sent (value from 001 up to 999) at the end of the folder

The «serial.txt» file is a text file (raw text without page setting) that can be created with any easy text editor like « notepad » from windows or similar. When recording, use «ANSI» coding . Do not use special characters.

The file «serial.txt» of RS232 codes is a text file containing one or several lines. Each of these lines will include a sequence of bytes expressed in hexadecimal and separated by a space (from 00h to FFh). You must only indicate the two characters of the wished hexadecimal value.

Each beginning of line of this file should present the following parameter:

#xxx : the xxx number of the line containing the bytes to send related to the xxx of the tag.

[RSS002]-> line #002 – the tag [RSS002] will send the sequence of bytes of the line #002 of the serial.txt file.

The separator between each byte is a space.

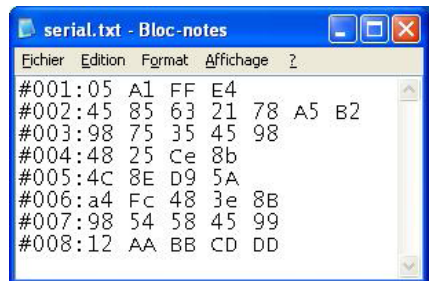

Example of a line contained in the serial.txt file.

```
#001: 45 85 63 21 78 A5 B2
#002: 98 75 21 35 45 98
#100: 21 35 45 78 A5 B2
```

It is also possible to add comments in the file by using two times the type «/» (slash) = //

```
// example file
#001: 05 A1 FF E4 // comment in the line
#005: 45 85 63 21 78 A5 B2
#100: 98 75 35 45 98 // my command
//other command
#064: 48 25 Ce 8b
#128: 4C 8E D9 5A //
#999: a4 Fc 48 3e 8B
// comments at the end of the file
```

An example to allow the triggering of the reading of the folder 001 for another VP250HD.

```
#001: 80 01 01
```

Example of tag:

```
001[RSS001][RSE002] : Sending of the bytes of the line #001 of the file serial.txt on reading of the folder 001
and sending the bytes for the line #002 of the file serial.txt at the end of the folder.
```

```
001[RSS001]: Sending of the bytes for the line #001 of the file serial.txt on reading of the folder 001
```

```
002[RSE064]: Sending of the bytes for the line #064 of the file serial.txt at the end of the folder 002
```

● Specific conduct:

If a folder is missing but a command designates this folder, the command is ignored.

● SYSTEM folder - This folder contains the configuration files

This folder is optional. It will be used to offer some extended functions.

SYSTEM\serial.txt -> File with the bytes to send by RS232 with the option [RSSxxx] and [RSExxx]

SYSTEM\scheduler.tm2 -> File for the scheduler

4.2 Organization of the Files inside the Folders

Like for the folders, the filenames define the behavior of the playback.

Note: The naming of the files is free if the playback is in random mode. ([RND] option or no option in the folder name). In this case, all the files are played and can be interrupted.

In sequential mode, the files are played in alphanumerical order. Playback options (tags) can be added as needed, like a blocking of commands or a temporary change of the volume.

[Jxxx]	Jumps to the another folder after reading the current folder.
[RET]	Returns to the previous folder after reading the current folder.
[Vxxx]	Controls the volume level of the folder
[V+xxx] [V-xxx]	Modifies the volume of the player during the playback of the selected folder
[WHL]	Plays the folder while the assigned input combination remains activated.
[NXTxxx]	Plays a specific number of audio files from the folder.
[SYNCHRO]	Starts the playback of several players at the same time
[RSSxxx] [RSExxx]	Sending of RS-232 codes at the begining or at the end of the folder
[RESxxxxxxxx] [REExxxxxxxx]	Actives or deactives the output contacts when the folder is played or at its end

Please refer to the previous chapter for the details of the options uses.

The functions of the options in the file name are similar to the options in the folder name.

● **[SYNCHROxxx]** - Synchronize several players to play simultaneously

The EVP380 models supports synchronization over Ethernet. You can synchronize a group of players and support many groups on the same network.

Each player can be «Master» and can send command to the «Slave» or can be «Slave» and can receive a command.

A player becomes a Master when it plays a file with the tag [SYNCHROxxx] in its name.

xxx is the name of file to be played through the Slaves players. Then you can synchronize at any moment or any context the players on the network.

A group is created with the value of the Ethernet port. By default the port is 44830.

You can change the value of the group manually in the menu. All players with the same port will be in the same group.

Master :

Create the folders. Inside the folder, select the file which will send the synchronisation command and add the tag [SYNCHROxxx].

Example :

001[J000]

Bird1 [SYNCHRO001].mp4

Cat.mp3

Dog [SYNCHRO002].mov

Files with tag [SYNCHRO] will send a command to the network. If other players are connected to the network with the same port, they will play the selected file.

Slave:

Create a root folder with the name «synchro». In this folder, place the files to be played with a number in the file name.

Example :

synchro

001 Bird2.mp4

002 [J001] Dog2.mov

4.3 Contact input

Contact input are used to play folders designated by the number of the activated entry. The VP330 has 1 separate input and 8 additional inputs.

The separate input is configurable in the menu and plays the 001 folder by default.

The 8 entries of the VP330 play the first 255 folders in a binary order.

Folder No. 001 is triggered by the separate input or input 1 of the group of 8 inputs.

The 8 input contacts are used to play the file numbers corresponding to the 3 digits of the file number following a binary order from 001 to 255. (see table in the appendices)

Entry 1: File 001

Entry 2: File 002

Entry 3: File 004

Entry 4: File 008

Entry 5: File 016

Entry 6: File 032

Entry 7: File 064

Entry 8: Folder 128

Simultaneous pressing of multiple input contacts offers up to 255 different combinations. Nos. 001 to 255 correspond to the combinations of the 8 input contacts.

Example to play the folders from the block of 8 entries:

001: activation of entry $N^{\circ} 1$

002: activation of entry $N^{\circ} 2$

003: activation of entries $N^{\circ} 1 + N^{\circ} 2$

004: activation of entry $N^{\circ} 3$

005: activation of entries $N^{\circ} 3 + N^{\circ} 1$

006: activation of entries $N^{\circ} 3 + N^{\circ} 2$

007: activation of entry $N^{\circ} 3 + N^{\circ} 2 + N^{\circ} 1$

008: activation of entry $N^{\circ} 4$

009: activation of entries $N^{\circ} 4 + N^{\circ} 1$

and so on following a binary progression. (see table in annex)

Note: You can also trigger folders via the RS-232 serial link of the player. To do this, please refer to the RS-232 serial link chapter.

5 - Show control and DMX link

The Event VideoPlayer is not only an audio / video file player, it can also play sequence files to control devices that meet the DMX512 standard or to control output contacts in sync with the audio and video file.

With the Show Control software, that you can download for free from www.id-al.com, you will be able to create scenarios managing both the sound playback and the sending of DMX commands to the devices connected to the player, in perfect synchronization.

We invite you to refer to the software manual to use this function.

On this output you will connect any device compatible with the DMX512 protocol. You can use dimmers, projectors, DMX converters to relays or to servomotors ...



5.1 Creation of a project with Show Control software

The principle is to create DMX event tracks or output contacts and then place the events in a grid according to the timeline and the associated audio file.

Once the file has been created, simply copy it to the Event VideoPlayer media with the audio files. The operation of the player is the same whether it is an audio file, an event file alone or the synchro playback of both. Folders and their options, trigger input contacts and all other control devices such as time programming work the same way. Of course, you can use as many event files as you want.

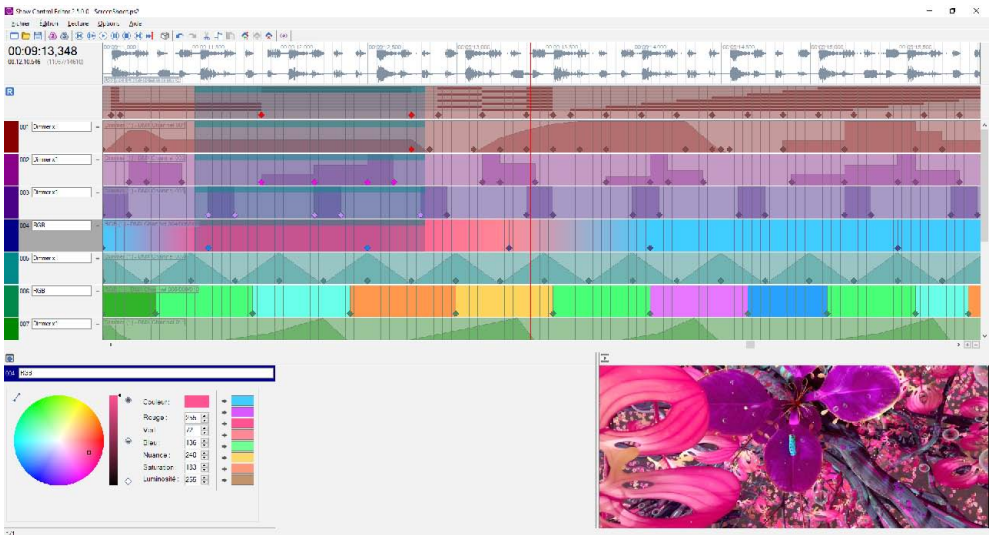

Creation phases in the software:

- 1 - Create a new project
- 2 - Open the audio file of the project to arrange it on the timeline.
- 3 - Display the DMX device patch and set the DMX channels used in the grid
- 4 - Place the different events in the tracks
- 5 - Save the file and transfer it to the media of the player (USB key, microSD, internal memory).

Exporting the result file

When your Show Control file is finished, you must export the items to a file and transfer it to the drive media.

- In the «File» menu click on «Build show file». Export your project with the name of the audio file. You do not have to change the extension named «.sc3»

- Copy this file to the media used in the player in the same location as the associated audio file.

The name of the event file must have the same name as the audio file to be read at the same time and thus synchronized.

Example:

001

Lion.mp3

Lion.sc3

**The software and the complete manual are free to download
from the site www.id-al.com**

5.2 Record a DMX or Art-Net show

The Show Control Editor software is an ideal tool to perform simple shows quickly. For the creation of complex shows with many DMX channels or using devices with many settings like moving lights, it is recommended to use a software dedicated to light or light mixing table that can provide much more complete tools without changing your uses.

To record a show in the Event VideoPlayer, you must first have copied your audio / video file in the media of your choice (USB key, Micro SD, internal memory) and have prepared the folders and their names accordingly (see chapter on managing folders / files). It is possible to record a show without associated file.

You can record a show from a DMX source via the DMX input of the player or from a system managing the Art-Net on the Ethernet network.

When you connect a DMX / Art-Net system to the player, you can monitor the result by positioning the player in a transparent data transfer mode. What is sent to the DMX input or the Art-Net network is returned identically to the DMX output. You can then check your show without disconnecting anything before the recording.

In the next chapter, you will learn how to use the player as a DMX / Art-Net remote control to trigger the playback of audio / video files from a light console.

First record

To record a show, you must proceed with some steps and first configure the player and the settings related to the recording. All these elements can be made within the setup menu of the player accessible with the infrared remote control or with a USB keyboard connected to the player.

Steps:

- 1 - Choose the media to record
- 2 - Select the folder that will contain the saved files
- 3 - Select either the associated audio / video file or let the player generate a name
- 4 - Set the conditions of the start recording
- 5 - Set the conditions of the end of recording
- 6 - Select the source of the DMX data to be saved
- 7 - Select the DMX source to use to control the device (output contacts, RS-232)

Important : The player can process and save 2 types of DMX data:

A- The DMX data that controls the light peripherals and other devices and that will be reproduced identically on the DMX output during playback.

B- The DMX control data which send command to the output contacts of the player to control the objects or devices but also the sending of RS-232 frames to turn on / off a video projector for example. This information is also saved in the result file for playback with DMX data.

This data are also used to control the player (playing a folder for example or changing a level of volume) with a DMX command when it is placed in the piloting mode.

Enter in the main setup menu and then select «Show Control» sub menu.

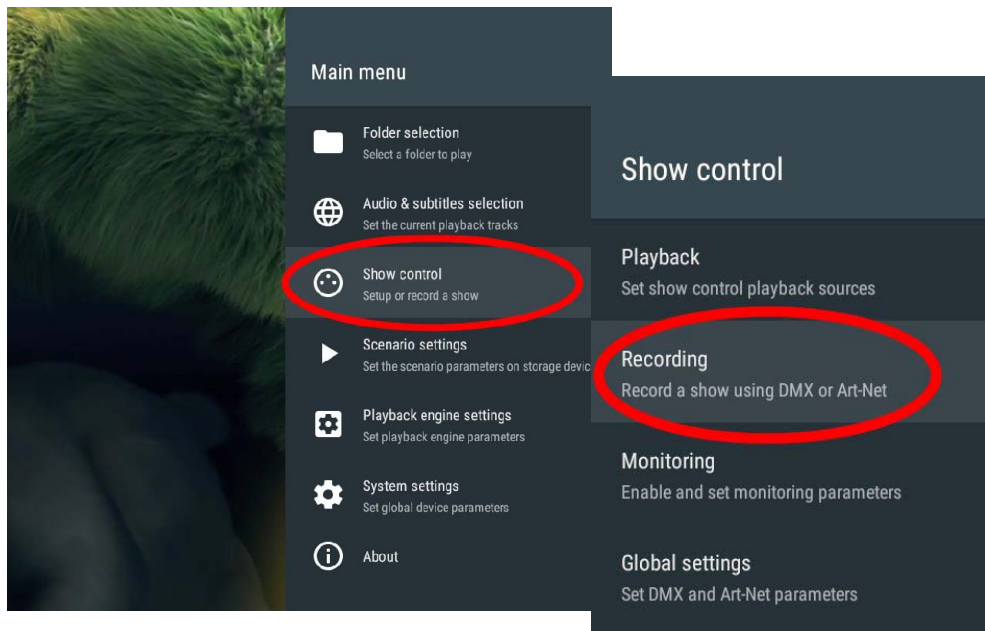

In the recording menu, select the parameters step by step

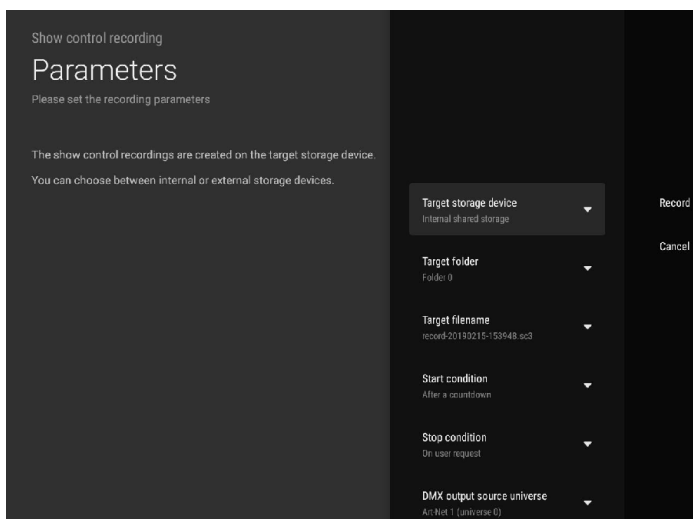

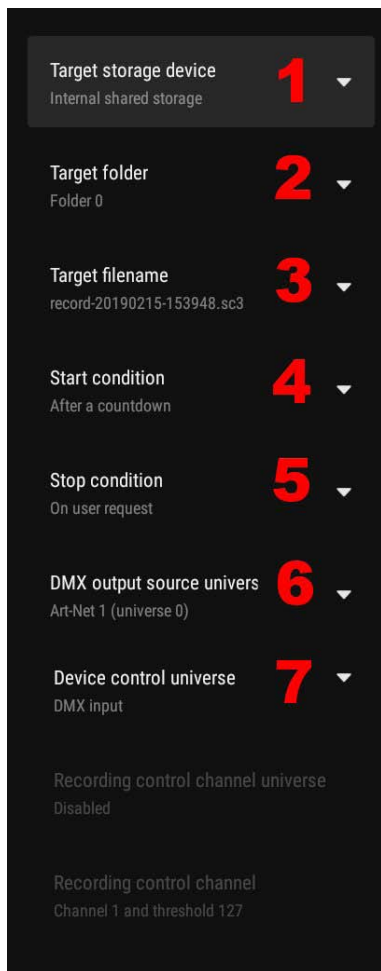

- 1 - Choose the media on which the files will be recorded
 - USB flash memory, Micro SD card or internal memory.
 - Only the connected media will be visible with their name
- 2 - Select the folder that will contain the file to be saved in the media
- 3 - Select the audio / video file that will be associated with the show, enter one manually or use the name proposed by the player.
- 4 - Set the conditions of the start recording
 - Upon receipt of a DMX frame
 - After a countdown of 5 seconds
 - When receiving a value on a dedicated DMX channel
- 5 - Set the conditions of the end of the recording
 - At the end of the associated audio / video file
 - After a fixed recording time (max 10h in steps of 1 seconds)
 - On manual stop (cancel or finalize button)
 - When receiving a value on a dedicated DMX channel
- 6 - Select the DMX data source to record
 - DMX input, Art-Net 1 or 2
- 7 - Select device control source (output relay, RS-232)
 - DMX input, Art-Net 1 or 2

If the start or the end of the recording is conditioned by the reception of a DMX value, it is necessary to configure the DMX channels and the values that will be used in the following menu.

When all the configurations are done, it remains to click on the «Record» button, the player will then wait for the condition to start the recording.

If you make a mistake, you can stop the recording at any time with click on Cancel then you can repeat the operation. Cancel does not memorize any information. With click on Finalize, you set the record to the file that will be written to the selected media.

Show control playing files and DMX remote control mode

Show control playback mode

To read the result of its recording or other files already in the media, you have to make sure that in the «Playback» menu, the «DMX output source» submenu is set to «File» so that the data sent on the DMX output come from the file. The other modes allow you to control the player in a remote control mode and also to trigger the playback of audio / video files in real time.

For the actions on the output contacts or the sending of RS-232 frames saved in the file to be played, you must also set the «Device control source» mode to «File».

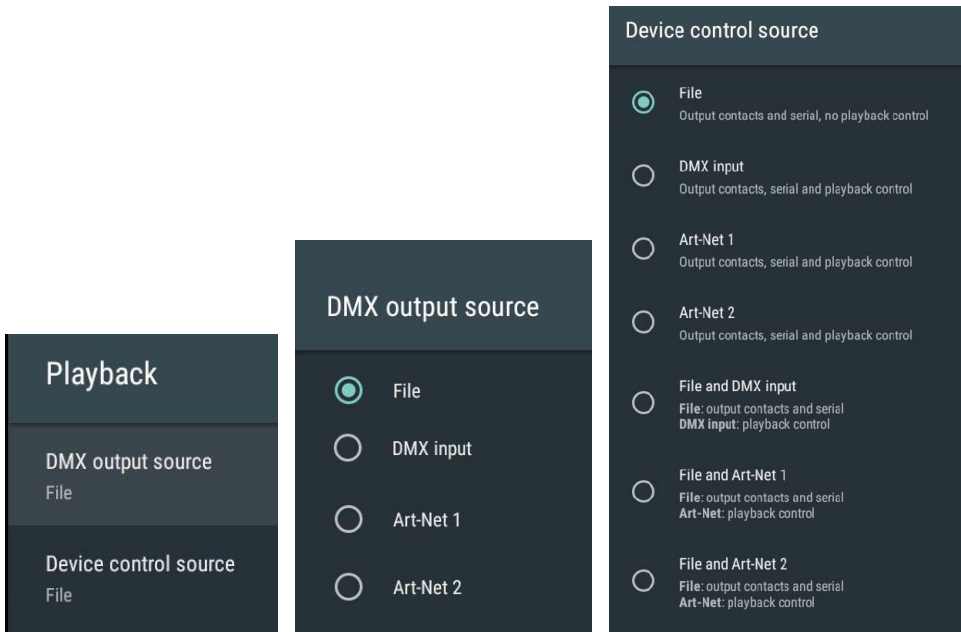

DMX remote control mode with DMX / Art-Net

The Event VideoPlayer is able to receive commands to play audio / video / event files from a real-time command (light mixing table or light software) in a live context such as a concert, a theater or any animation requiring video projections and/or manually controlled sound interventions. For example, the lighting controller can send command to display images or deliver messages at the required moment following the performance of a show.

The two sub-modes, control of the contacts output and RS-232 frame and control of the playing files are separated into 2 parts, each can be manually controlled or pre-recorded in a file or the combination of both.

Example: Play audio / video files only, controlled by a DMX console.

The player behaves like a DMX device, the DMX data which comes through the DMX input are the same on the DMX output. The output contacts and the RS-232 of the player are not used.

The image shows three screenshots of the software interface. The leftmost screenshot shows the 'Playback' menu with 'DMX output source' and 'Device control source' both set to 'File'. The middle screenshot shows the 'DMX output source' menu with 'DMX input' selected. The rightmost screenshot shows the 'Device control source' menu with 'DMX input' selected.

To control the player from a DMX console, you must perform the DMX mapping, ie define on which channels the player will react to commands. The channel configuration is done in the menu «Global settings» / «Device mapping» / «Device address» - The result is visible in the «Channel assignment» window.

The image shows three screenshots of the software interface. The leftmost screenshot shows the 'Global settings' menu with 'Device mapping' selected. The middle screenshot shows the 'Device mapping' menu with 'Device address' and 'Channel 1' selected. The rightmost screenshot shows the 'Channel assignment' window with a table of channel descriptions.

Channel	Description
1	Playback state
2	Change folder trigger
3	Folder number
4	Absolute volume
5	Output contact 1
6	Output contact 2
7	Output contact 3
8	Output contact 4
9	Output contact 5
10	Output contact 6
11	Output contact 7
12	Output contact 8
13	Send serial frame trigger
14	Serial frame number

Value of the DMX channel:

- Playback State: 0 - 63 -> STOP / 64 - 191 -> Pause / 192-255 -> Play
- Change folder trigger: 0-127 -> OFF / 128-255 -> Validate the command
- Folder number: 0-255 -> Folder number to play
- Absolute volume : 0-255 -> 0 to 100% of the volume
- Output contact 1 à 8: 0-63 -> OFF / 64-191 -> Neutral zone / 192-255 -> ON
- Send serial frame trigger: 0-127 -> OFF / 128-255 -> ON
- Serial frame number: 0-255 -> Frame number from the serial.txt file

A folder playback command is generated when channel 2 change to ON (whether channel 3 has changed or not) or when the value of channel 3 changes while channel 2 is ON.

The final playback status reflects the value of channel 1 (STOP / PAUSE / PLAY).

Example of DMX command to play folder 006

- On channel 3, select value 006
- On channel 1, select play mode and send a value over 192
- When you are ready, send a value over 128 on channel 2 to start playback.

To stop playing

- On channel 1, select STOP mode with a value under 63
- When you are ready, send a value over 128 on channel 2 to stop.

DMX monitoring for a show preparation

You can prepare your show without stopping anything or changing the configuration, with the use of the monitoring function. What enters the player in DMX or Art-Net is identical on the DMX output.

The data coming from Art-Net link is transferred to the DMX output.

You can unlink the 2 DMX data modes and use two different sources if needed:

A - The DMX data that controls the light peripherals and other devices and that will be reproduced identically on the DMX output.

B - The DMX control data which send command to the output contacts of the player to control the objects or devices but also the sending of RS-232 frames to turn on / off a video projector for example.

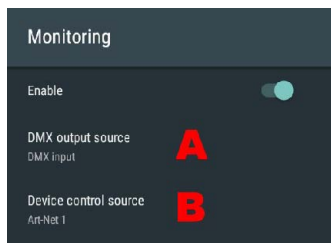

Attention, the monitoring mode display a banner at the top of the screen to indicate this mode of operation.

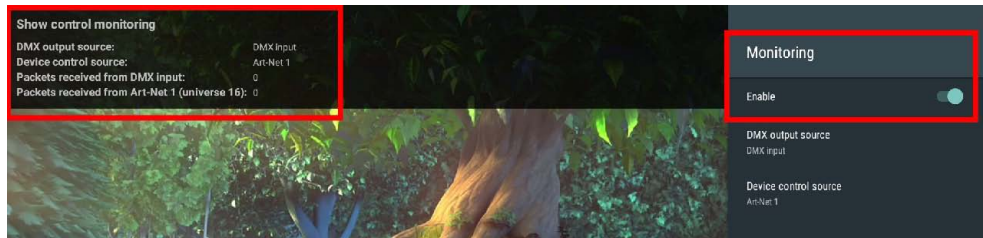

6 - Control with a Timestamped Programming (Scheduler)

6.1 Introduction

The EVP380 can be controlled thanks to a timestamped programming. This feature, named Scheduler, allows to timetable the playback of audio files (messages, spots, musics, sounds) and to stop or resume the playback on accurate date and time.

6.2 Principle

The EVP380 uses its built-in clock to perform scheduled actions. These actions are stored in a timestamped programming file named the Scheduler file.

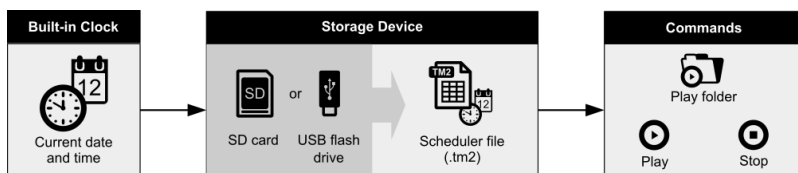

First, create a «Day template», (Monday, Saturday, Closed day, Special offer day...) where you will place the actions during the day (message, other folder, awake mode...). Then place the day template in the calendar and export the scheduler file to be copied on the media.

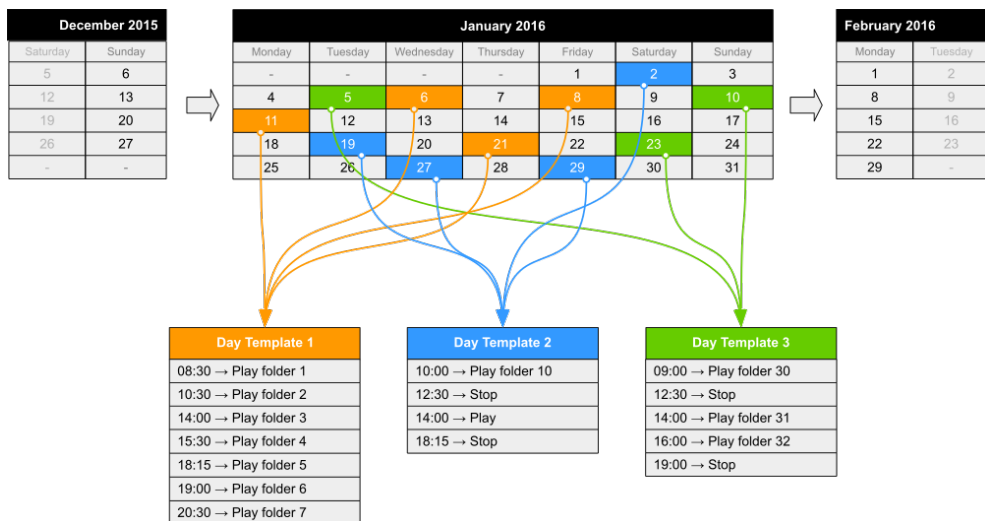

Notes :

- The dates requiring no actions are left empty and do not refer to any day template.
- If several dates require the exact same set of actions, then the calendar can refer to the same day template for these dates.

A day template contains all the events of a full day, for every minute, from 00:00 till 23:59. These events describe the command (action) to execute and when (precise time).

With the Scheduler feature:

- A schedule can contain up to 65535 different day templates.
- Within a day template, a different command can be scheduled for each minute.
- An action takes place precisely upon minute change.
- An event can execute a one-time command.

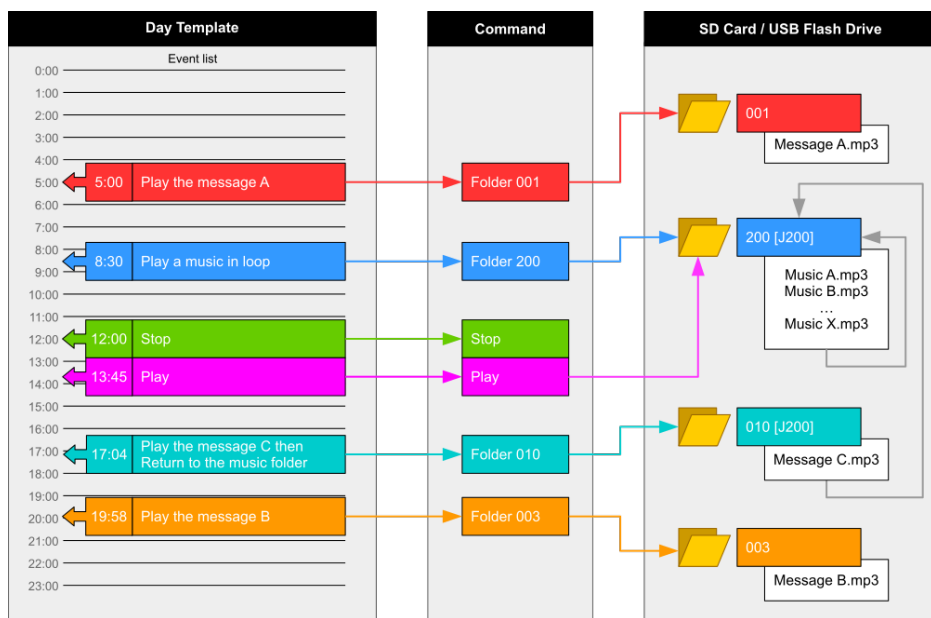

The following commands can be attached to an event:

PLAY FOLDER: launch the playback of a folder containing audio files (up to 1000 folders supported). This command requires the number of the folder to play (3 first digits between 000 and 999). The folder has to be stored in the root folder of the storage device. The way a folder is played depends on the tags appended to its name (loop: xxx[Jxxx], random: xxx[RND], sequential: xxx[SEQ]) (see the chapters Organization of the Folders).

PLAY: launch the playback of the folder in which the player stopped. If no folder playback action predates this command, or if the player stopped because out of a folder, this action is ignored.

STOP: stop the playback within the folder being played.

Un événement peut effectuer les commandes suivantes:

5.3 Creation of a Timestamped Programming File

The timestamped programming is stored in a Scheduler file. This file is generated with the Scheduler software developed for this purpose. Please check our website for additional information (www.id-al.com). The files generated with the Scheduler software are TM2 files with the .tm2 extension.

The file must be named: scheduler.tm2 and copied in the SYSTEM folder of the storage device.

**Scheduler software and complete manual could be downloaded
for free from the web site www.id-al.com**

7 - RS232 serial link protocol

The EVP380 can communicate with other devices with the receipt of instructions onto the Rx input or transferring data through its Tx output. The player complies with the RS-232 norm (refer to the appendix).

Value by default: 19200 Bauds - 8 bits - no parity - 1 bit start - 1 bit stop

You can change the baudrate manually in the menu.

7.2 - Reception Protocol

With the input protocol, the player can receive instructions to launch a folder playback or sets the volume control. On the other hand, in a framework of using several players on the same link, the player answers to its own number (defined in the file `config.txt`, see chapter related) or to a general command

The reception protocol is made of a 3 bytes frame.

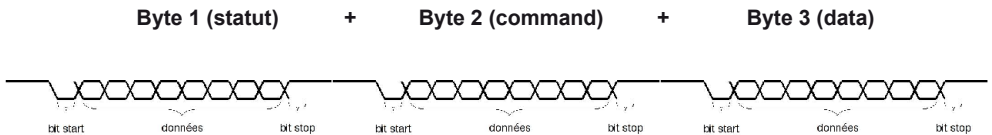

Reminder:

- a byte is composed of 8 bits: b7 b6 b5 b3 b2 b1 b0
- a binary representation is noted: 10000000b or in hexadecimal : 80h

Byte 1 : Status - 1xxxxxxx

The byte status is a synchronization information of frame. Its Byte 8 (b7) is always at 1. All others bytes (commands or datas) have their byte 8 to 0.

b7 = 1: refer to a status byte

b6 - b0: identification of the player to be addressed from 001 to 127 (000001b - 1111111b)

- The address of the player is by default (ID) 001. You can modify it in the configuration file.
- Several players may have the same identification number to create groups.
- Identification 000 is the «overall» code, all players are concerned by the command (unique command for all the players).

Example:

80h = «overall» code for all the players

81h = player n°001

9Eh = player n° 030

FFh = player n°127

Byte 2 (Command) 0xxxxxxx + Byte 3 (Data) 0xxxxxxx

The Byte 2 is a command and the byte 3 is a data that completes the command byte. A command byte is always followed by a byte of data. A full frame is therefore made of 3 bytes.

b7 = 0 : refer to a byte of command or data

b6, b5, b4, b3, b2, b1, b0 : command code sent to the player

List of commands:

00h	Not used
01h/11h/21h/31h/41h/51h/61h/71h	Command of a jump into a folder
02h	Transport bar command
03h	Volume control command
04h	Request informations
05h/06h	Reserved
07h à 7Eh	Not used
7Fh	Identification number change (ID)

● **00h - 00000000b: not used**

● **01h to 71h - 0xxx0001b : command of a jump into a folder**

The folder is designated by the bank number and the following data byte.

xxx is the bank number. In order to be able to launch 1000 folders (from 000 to 999), it is necessary to divide this number into several folder ranges (banks) of 128 values.

0xxx0001b: xxx = bank number depending on the folder number

01h - 00000001b	Bank 0 -> from 000 to 127
11h - 00010001b	Bank 1 -> from 128 to 255
21h - 00100001b	Bank 2 -> from 256 to 383
31h - 00110001b	Bank 3 -> from 384 to 511
41h - 01000001b	Bank 4 -> from 512 to 639
51h - 01010001b	Bank 5 -> from 640 to 767
61h - 01100001b	Bank 6 -> from 768 to 895
71h - 01110001b	Bank 7 -> from 896 to 999 (other value over 999 are ignored)

Method of calculation:

Bank = value in the above table depending on the folder number.

Value = folder number - (bank number x 128).

Example of a frame launching the folder 278 for the player number 001:

Folder number = 278

278 is in bank 2 (from 256 to 383).

Value = 278 - (2 x 128) = 22 = 16h.

For this example, the complete hexadecimal frame is: 81h 21h 16h.

● **02h - 0000010b: Transport bar command**

The transport function is defined by the data byte as follows:

Value of the datas of the byte 3 (datas)

01h - 00000001b	Playback
02h - 00000010b	Stop
03h - 00000011b	Next file in the current directory
04h - 00000100b	Previous file in the current directory
05h - 00000101b	Pause / Play
06h - 00000110b	Play next folder
07h - 00000111b	Play previous folder
08h : 00001000b	Stand by / Wake up
09h: 00001001b	Increases the volume by +1 step
0Ah: 00001010b	Decrease the volume by -1 step
0Bh: 00001011b	Not used
0Ch: 00001100b	Stand by
0Dh: 00001101b	Wake up
0Eh: 00001110b	Pause
0Fh: 00001111b	Resumes playback after a pause
10h: 00010000b	Mute or Unmute the sound of the audio output
11h: 00010001b	Mute the sound of the audio output
12h: 00010010b	Unmute the audio output to its previous level

Note: the other values are ignored.

Example of the complete frame to stop the player : 81 02 02

Byte 1 : 10000001b (81h) : Status byte, player ID 001

Byte 2 : 02h - 00100001b : Transport bar command

Byte 3 : 02h - 00010110b : Stop command

Note: Other values are ignored

● **03h - 00000011b : Volume control command**

The value of the volume is defined by the datas byte as follows:

00h - 00000000b : mute - volume at 0

10h - 00010000b : half volume - value 50

1Fh - 00011111b : maximum volume - value 100

Note : the others values are ignored

Example of the full frame : 81 03 0E

Byte1 : 81h - 10000001b : status byte, plater number 001

Byte2 : 03h - 00000011b : volume command

Byte3 : 0Eh - 00001110b : volume setting at 14

● 04h - 0000100b : Request informations

An external peripheral device can ask the player to render informations like status (Play, stop), current file/folder, remaining time...

Value of the data byte:

01h - 00000001b	Player status du lecteur -> PLAYING / STOP / PAUSE / ERROR
02h - 00000010b	Current file name -> example : bird.mp4 - If stop mode, the last file played
03h - 00000011b	Complete path folder/file name- Exemple : Example : 001/bird.mp4
04h - 00000100b	Media used -> USB / SD / Internal memory
05h - 00000101b	Not used
06h - 00000110b	Folder number -> 001 to 999 - Example : 005
07h - 00000111b	Not used
08h - 00001000b	Not used
09h - 00001001b	Remaining time -> hh:mm:ss - Example : 00:05:14
0Ah - 00001010b	Total time of the file : hh:mm:ss - Example : 01:42:27
0Bh - 00001011b	Volume value -> xx (00 to 100) - Example : 16

When the player receives a request command, it sends the information in ASCII mode on the Tx pin of the RS232 link.

Example1:

Frame to send to the player to request status: 81 04 01

Byte1 : 81h - 10000001b : status byte, player number 001

Byte 2 : 04h - 00000100b : Request informations

Byte 3 : 01h - 00000001b : Request status

Player send : PLAY + CR/LF -> in ASCII -> 50 4C 41 59 0D 0A (Value in Hexa)

Example 2:

Frame to send to the player to request remaining time : 81 04 09

Byte1 : 81h - 10000001b : status byte, player number 001

Byte 2 : 04h - 00000100b : Request informations

Byte 3 : 09h - 00001001b : Request remaining time

Player render: 00:03:12 + CR/LF -> in ASCII = 30 30 3A 30 33 3A 31 32 0D 0A (Value in Hexa)

● 05h à 7Eh : Not used

● 7Fh - 01111111b : Command in order to change the identification number of the player (ID)

You can change the ID (Identification number) of the player for the RS232 link. The default value is 001. You can change value from 001 to 127. The data byte defines the number of the new ID.

Example of a complete frame to change ID to 002: 81 7F 02

Byte1 : 81h - 10000001b : status byte, player number 001

Byte 2 : 7Fh - 01111111b : ID change command

Byte 3 : 02h - 00000010b : ID N° 002

8 - Ethernet

Via Ethernet, the EVP380 can update content via FTP (SD card, USB flash memory, internal memory).

You can use the player on a local network. An adequately configured Modem/Router will allow to update the player via the Internet.

Caution! Network administration requires good computer skills.

With a local network installation, the player requires an IP address. This address is set in the Option menu (see option menu chapter). The player is then recognized on the network as a FTP server with a FTP software such as «Filezilla».

In an installation where only the player is present or on a local network with an external access, you must use a Modem/Router to create a gateway between the player and the Internet. Since the Modem/Router is configured with an IP gateway, you must declare this gateway to the EVP380 so it can communicate outside (to be configured in the Option menu).

Note: The EVP380 offers a DHCP mode by default to get an IP address automatically. When the player is connected in FTP mode, the player is in stop mode and can't play anything.

Host: IP address

Default User: : idalftp

Default password: idalftp

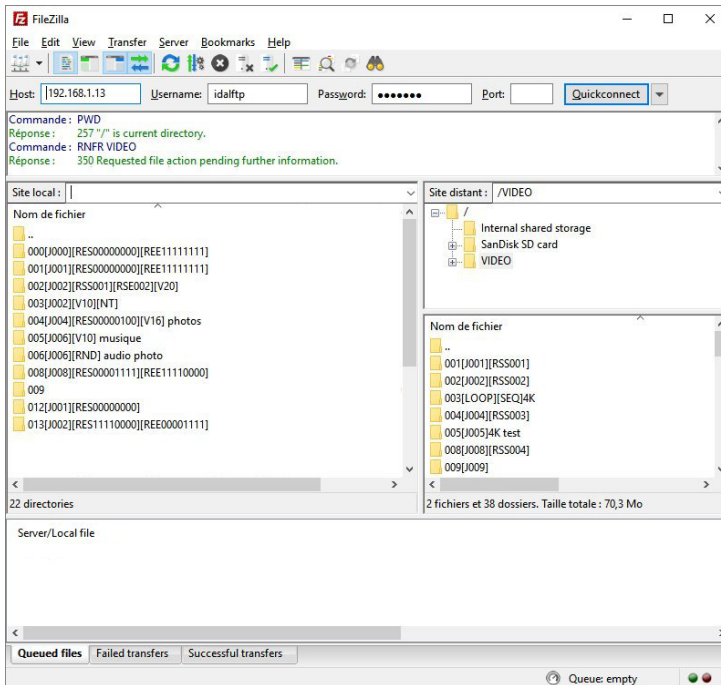

You can change manually the user / password in the menu.

9 - Menu

To configure the player settings, press the «MENU» button on the remote control.

You can then navigate through the different menus with the arrows on the remote control to change the setting you want. OK to validate, ESC to cancel. MENU to exit the menu.

Main menu: Main menu displayed when you press the button on the remote control

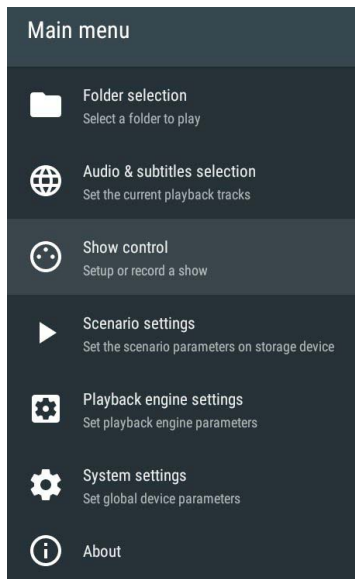

Folder selection: To see the media content and play manually the folders

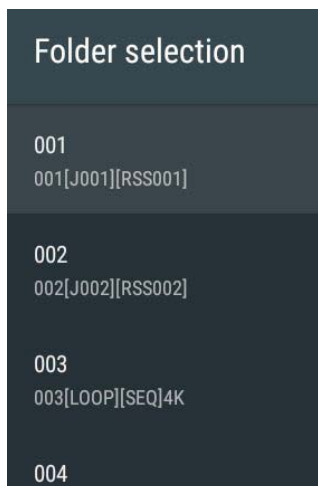

Audio & Subtitle selection : Display audio characteristics and subtitles.

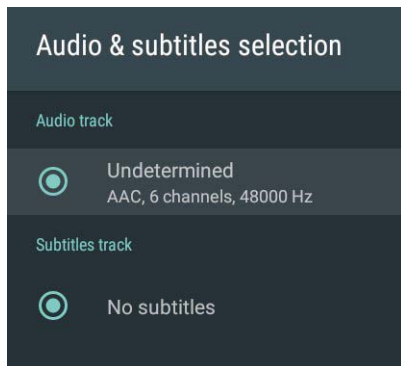

Scenario settings: Allow to modify the behavior of the player

 **Be careful changing these parameters creates a file on the media «scenario.json» in the SYSTEM folder. If this file is manually removed from the media, these configurations will be lost.**

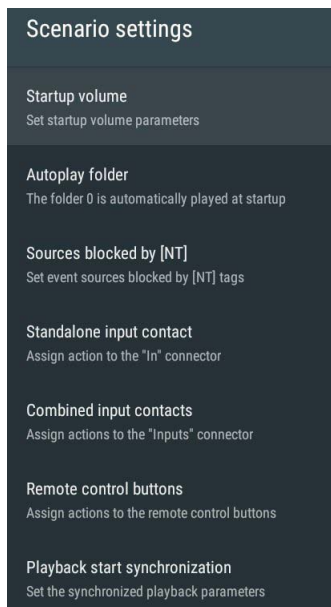

Playback engine settings: Allows you to configure basic playback settings such as the media to use, the duration of slideshow images, and various other settings.

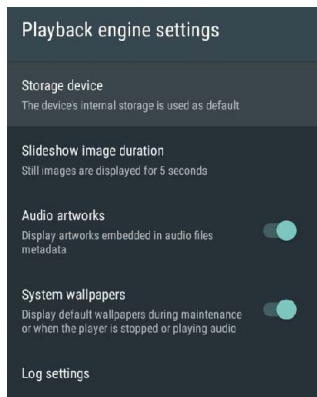

System settings: General configuration menu of the player (network, screen, date / time ...)

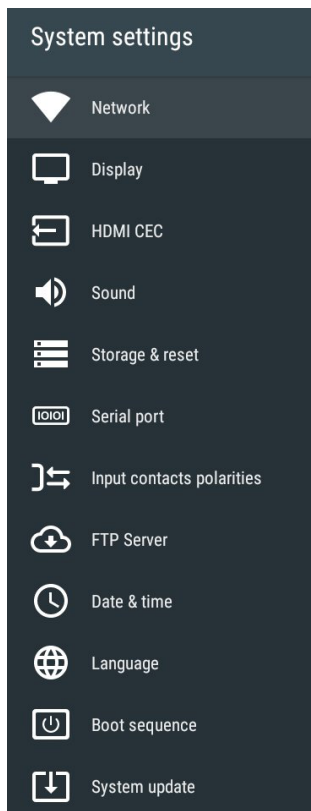

About : Informations about the player



About

Model
VP330

Serial number
0123456789abcdef

System version
7.1.2 v0.97

Firmware date
September 11, 2018 12:32:20 PM GMT+00:00

ID-AL by Waves System
Copyright (C) 2018 Waves System. All rights reserved.
Web site: <http://www.id-al.com>

Appendix A - Characteristics

Interface and connectors

- LED status indicator
- LCD display 2 x 16 characters
- Clickable knob (volume)
- Infrared sensor - Protocol: NEC
- HDMI Type-A (standard) receptacle connector (HDMI 2.0b, HDR10 and CEC and HDCP v2.2)
- 2 USB Host 2.0 High Speed (480Mb/s), type-A receptacles
- microSD card slot
- 0 dBu unbalanced line-level stereo audio output on standard RCA connectors
- 10/100 Mbps Ethernet, RJ45 connector
- Headphone stereo audio output on a standard 3.5mm (TRS) jack
- Class D amplified speaker stereo audio output on 3.81mm pluggable terminal blocks
- Power supply output on a pluggable terminal block
- External DC power supply chassis socket – Plug Ø 2.1mm / 5.5mm
- 8+1 configurable opto-isolated inputs on a 3.81 mm pluggable terminal block
- 8 MOSFET outputs (500mA per output, max 20V) on a 3.81 mm pluggable terminal block
- DMX input and output on XLR 3 points connectors
- RS-232 serial link on a 3.81 mm pluggable terminal block (9600, 19200, 38400, 57600, or 115200 bauds)
- 3 additional power supply outputs dispatched on the pluggable terminal blocks
- 5 V DC - 500mA output on a pluggable terminal block

Output Video Formats Supported

- 4K Ultra HD (3840 × 2160), 24/25/30/50/60 Hz
- 1080p (1920 × 1080), 24/50/60 Hz
- 1080i (1920 × 1080), 50/60 Hz
- 720p (1280 × 720), 50/60 Hz
- 576p and 576i (720 × 576), 50 Hz
- 480p and 480i (720 × 480), 60 Hz
- Dynamic range: HDR10 compatible

Multimedia Container Formats Supported

Video:

- .mp4 (MPEG-4)
- .mkv (Matroska)
- .mov (QuickTime)

Picture:

- .jpg or .jpeg (Joint Photographic Experts Group) (ISO/IEC-10918)
- .png (Portable Network Graphics)
- .bmp (Bitmap)

Audio:

- .wav (WAV)
- .mp3 (MPEG-Layer 3)
- .m4a (MPEG-4 Audio)
- .ogg (OGG, Opus and Flac)

Multimedia Codecs Supported

Video:

- H.265 HEVC MP-10@L5.1 up to 4K×2K@60fps
- VP9 Profile-2 up to 4K×2K@60fps
- H.264 AVC HP@L5.1 up to 1080p@60fps and 4K×2K@30fps

Picture:

- JPEG unlimited pixel resolution (ISO/IEC-10918)
- PNG unlimited pixel resolution
- BMP unlimited pixel resolution

Audio:

- WAV: mono/stereo, up to 24-bit LPCM@96kHz, WAVE_FORMAT_PCM (WAVE_FORMAT_EXTENSIBLE Format not supported)*
- MP3: MPEG-1/2 Audio Layer III, mono/stereo, 16 bits up to 48kHz@320 kbit/s, CBR (Constant Bit Rate) or VBR (Variable Bit Rate) files, with or without ID3v1/2 tags
- AAC-LC: Advanced Audio Coding, mono/stereo, up to 96kHz@512 kbps.
- HE-AAC-LC: High-Efficiency Advanced Audio Coding, mono/stereo, up to 96kHz@512 kbps.
- Vorbis: mono/stereo, up to 48kHz@350 kbps.

Other File Formats Supported:

- TM2 (.tm2): timestamped programming file (scheduler.tm2) - Scheduler V2 file format
- SC3 (.sc3): Show control file

File systems supported:

- FAT32 (read/write)
- exFAT (read/write)
- NTFS (read/write)
- ext2/3/4 (read/write)

Accepted storage device types:

- microSDSC / SDHC cards
- USB flash drives
- Internal storage: 4 GB

Network:

- Embedded FTP server for remote content update
- Embedded NTP client
- IPv4 and IPv6
- IPv4: static or DHCP address
- Embedded mDNS identification service (Zeroconf)
- Multicast "Start Synchro" facilities over UDP
- Art-Net protocol input only

Built-in Clock:

- Timekeeping when the player is not powered: up to 2 months

Audio amplifiers :

Headpone output

Maximum output power:

2 × 15 mW for 32 Ω

2 × 30 mW for 16 Ω

THD+N:

0.014 % for 2 × 5 mW, 32 Ω, 1 kHz

0.016 % for 2 × 10 mW, 32 Ω, 1 kHz

0.022 % for 2 × 10 mW, 16 Ω, 1 kHz

0.028 % for 2 × 20 mW, 16 Ω, 1 kHz

Speaker output:

2 × 8 W - 8 Ω, THD+N = 1 %, 1 kHz

2 × 10 W - 8 Ω, THD+N = 10 %, 1 kHz

2 × 15 W - 4 Ω, THD+N = 1 %, 1 kHz

2 × 19 W - 4 Ω, THD+N = 10 %, 1 kHz

Power supply:

- Nominal voltage: 12 V DC - The player is protected against polarity reversal.

Typical Current Consumption (12 V supplied):

- Playback content on its embedded internal memory, without amplifier: up to 500 mA

- Playback content on a USB flash drive with amplifier: up to 3A

Thermal Information:

- Operating ambient temperature: from 0 to +40 °C

- Storage temperature: from -20 to +60 °C

Dimensions :

- Width: 143 mm - 1/3 of a 19-inch rack

- Height: 44 mm - 1U

- Depth (with terminal block connectors): 140 mm



















Weight:

- VP320: 365 g (with the pluggable terminal blocks)

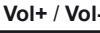
- VP330: 480 g (with the pluggable terminal blocks)

Appendix B - Infrared remote control

You can send command to player using an infra red remote control.

Key	Function	
	Power on/off	Short press: standby/wake-up Long press: power off / restart
	Mute/Unmute	
	Rwd / Fwd	Skip 10 seconds backward/forward
	Play/pause	
	Stop	
	Functions customizable	Programmable buttons. Setup in the menu. Play folder 001 to 004 by default
	Information	Display informations on screen
	Exit	
	Up/Dn Left/Right	In menu context: up/down - left/right In playback context: next/previous folder/file
	Validation	Validate selection
	Menu	Display menu
	Back	
	Volume	Increase/decrease the volume
	Functions customizable	Programmable buttons. Setup in the menu. Play folder 005/006 by default
		When selecting a value, typically with a slider control, skip many values
	Numeric keypad	In menu context: digit characters In playback context: play folder 0 to 9
	Dot	Dot character
	Erase	Erase previous character



Appendix D - Accessories

You can use some accessories with your VP3x0 players



Rack support 19" - 1U



15 input extension board for VP330



Wall or table mount



Vibro Pad - Audio transducer for cardboard



Antivandal push button



Senso PAD - Capacitive push button



IR PAD - IR motion sensor

Appendix E - Frequently Ask Questions

I don't know how my file is encoded. Which software can I use to know precisely which are the characteristics of my file? (format, type, encoding, bitrate...)

If you have not any software for this, you can use MedialInfo software (<http://mediaarea.net/fr/MedialInfo>). This software, provided under BSD license, is free and opensource on all operating system (Windows, Mac OS X or Linux).

I have not any software to re-encode my video file in a format compatible with my player. Which software do you recommended?

This question is wide, because many encoding softwares exist. It would be simplistic for us to summarize all free and commercial solutions in a single reference. In a first time, refer to your owner's manual to be aware of the formats supported by your player. If you can not find reference encoding software, you can use the Handbrake software (<http://handbrake.fr/>). This software, provided under GPL license, is free and opensource on all operating system (Windows, Mac OS X or Linux). It allows you to encode your video files into H.264 in MP4 contenaire.

I have properly named «000» the autoplay folder, but the player reads the folder just one time, what is the problem?

By default, the folders are not played in loop. The condition to play a folder in loop depend to the add of a specific parameter in the name of the folder. This parameter is a jump function, done when the folder is fully played. To play your folder in loop, please, rename the autoplay folder from «000» to «000 [J000]». For more informations on the folders parameters, please, refer to your owner's manual.

I have created a text file «serial.txt» as specified into the manual, but the player does not include instructions that i put in the configuration file. Why?

Make sure that the «serial.txt» file is generate with a basic text editor like the «Notepad» of Microsoft Windows. Otherwise, your text editor needs to create a «ANSI» file, 100% ASCII. «DOC», «RTF», «»UTF-8», «UTF16», «UNICODE» or other format of text file are exclude.

Information about video formats

A video is a succession of images to which are added sound, titles and subtitles, called «metadata». All these elements are then placed and compressed in a file called «container» identified by its name as mov, mp4, mkv ... The higher the quality of a video, the larger the file created, it is for that we use a CODEC compression algorithm for compression and decompression.

The disadvantage is that during compression the quality of the video may drop depending on the method used. The choice of format is important. Video files use different codecs to encode and compress data. They are not all data formats, for example .mov is a container with no indication of the type of Codec used.

Inside these containers, the files can be compressed with different CODECs. VP3x0 supports H265 / H264 and VP9 codecs.



**Design and manufacturing of interactive
audio and video players**

**Check our products, informations
and technical solutions on our website:
www.id-al.com**